

SUPER RECORD ROAD GROUP	pages 6-7
SUPER RECORD GEAR - RECORD FRONT CHANGER AND ALTERNATIVE RECORD CONTROL LEVERS	pages 8-9-10-11
SUPER RECORD ROAD HUBS	page 12
SUPER RECORD ROAD PEDALS	page 13
SUPER RECORD CHAINWHEEL SET - ROAD BOTTOM BRACKET SET	pages 14-15
SUPER RECORD ROAD HEAD SET SUPER RECORD SEAT PINS	page 16
FORK ENDS - SPECIAL CONNECTORS	page 17
SUPER RECORD BRAKES	pages 18-19

4000/F CAMPAGNOLO SUPER RECORD ROAD GROUP

(Particular components of this group are illustrated from page 8 to page 19)



- 606 Down tube control gear inner wire (118 cm.)
 - 608 Down tube control front changer inner wire (72 cm.)
 - 622 Gear stainless steel outer casing (21 cm.)
 - 626/A Twin gear cable clip
 - 636 Chainstay clip
 - 649 Stainless steel brake cable clip
 - 1010/A Set Record front and rear fork ends without eyelet
 - 1014 Twin down tube control lever.
 - 1030/2 Pump connector
- 1049/A Super Record road chainset (with cranks 170 mm. pedal hole \varnothing 9/16" x 20 F. and chainrings for chain 1/2" x 3/32" [2 mm.]). Specify the number of teeth of the chainrings available from 42T to 57T. Upon request are furnished cranks with lengths 165 - 167,5 - 172,5 - 175 - 177,5 and 180 mm.

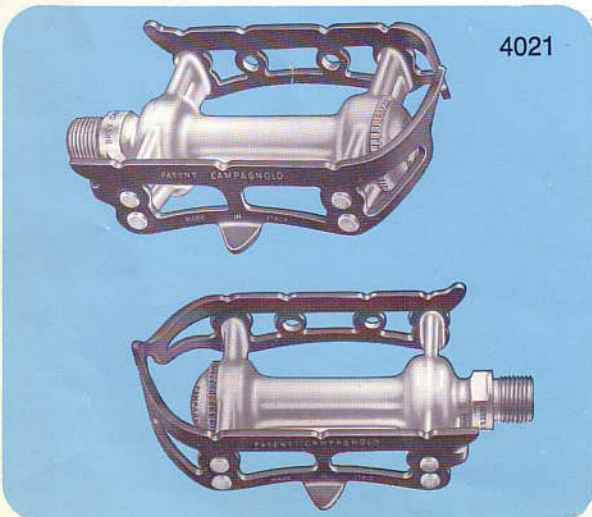
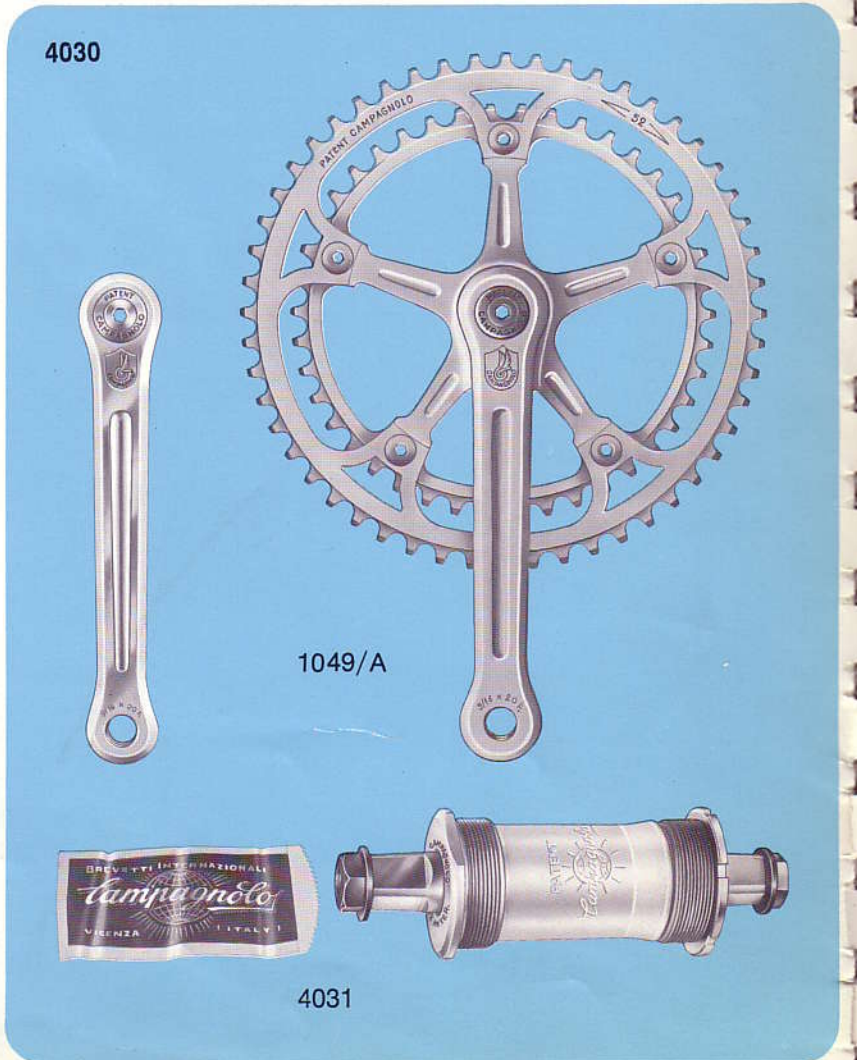
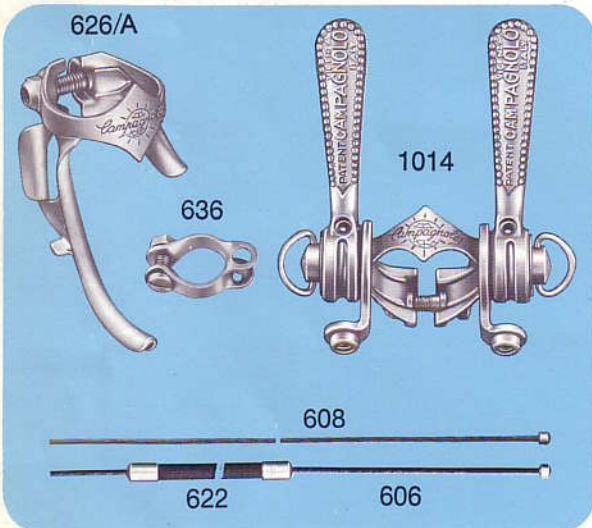
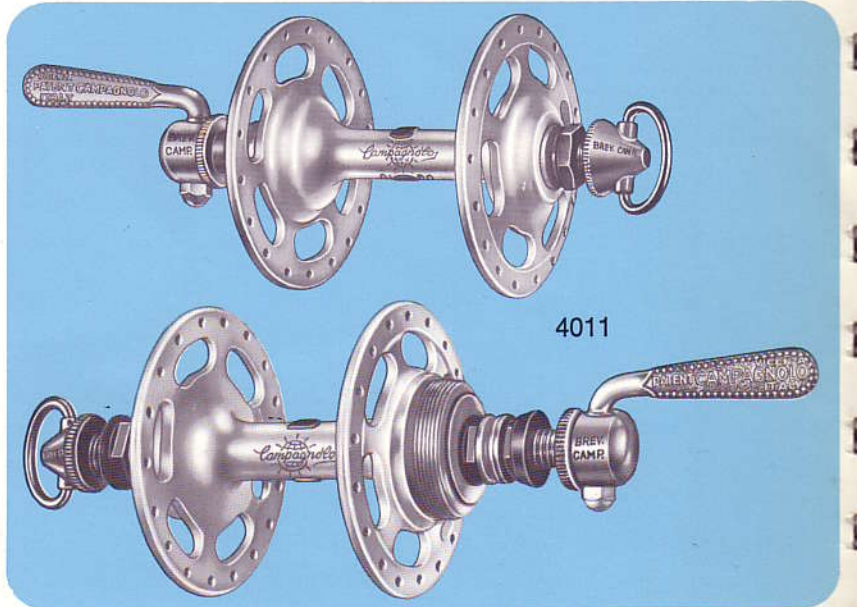
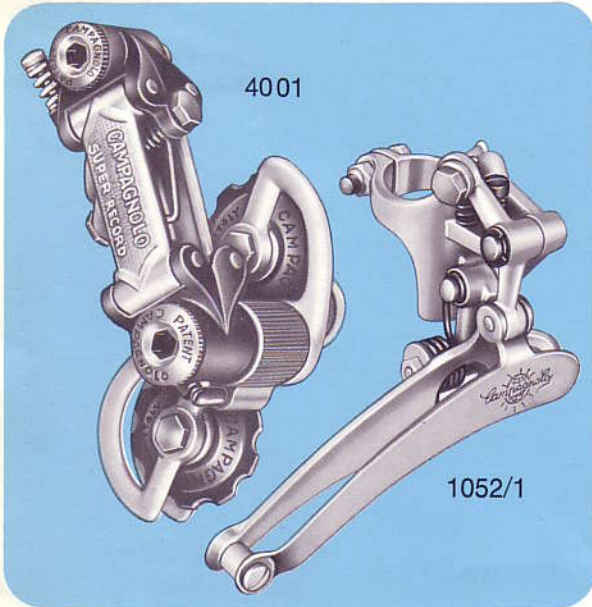

1052/1 Record front changer
4001 Super Record gear
(without hanger)

4011 Pair Super Record large flange
quick release road hubs with
Titanium spindle (front width
100 mm. - rear width 120 mm.,
flanges with 36 holes,
thread \varnothing 35 x 24F.).
Upon request furnished with
rear hub suitable for
6 sprockets, width 125 mm.,
flanges with 24 - 28 - 32 - 40

4021

holes, thread \varnothing 34.7 x 1 M. or
 \varnothing 1,370" x 24 Tpi-BSC.
See other alternatives on page 12
Pair Super Record road pedals
with Titanium spindle
(spindle thread \varnothing 9/16 x 20F.).
The pedals are supplied with
unassembled screws and washers
for fixing toe clips
4030 Super Record road chainwheel
set
4031 Super Record bottom bracket
road set with Titanium spindle
(bracket width 70 mm. and cups

4041

threaded \varnothing 36 x 24F.).
See alternatives on pages 14-15
Super Record road head set
(thread 25,4 x 24F.).
Upon request furnished with
thread \varnothing 25 x 1M. or
 \varnothing 1" x 24 Tpi-BSC
4051 Super Record seat pin.
(pin length 147 mm.)
Specify diameter stem: 25 -
25,8 - 26 - 26,2 - 26,4 - 26,6 - 26,8
- 27 - 27,2 - 27,4 mm.
4061 Set Super Record brakes.
See alternatives on pages 18-19

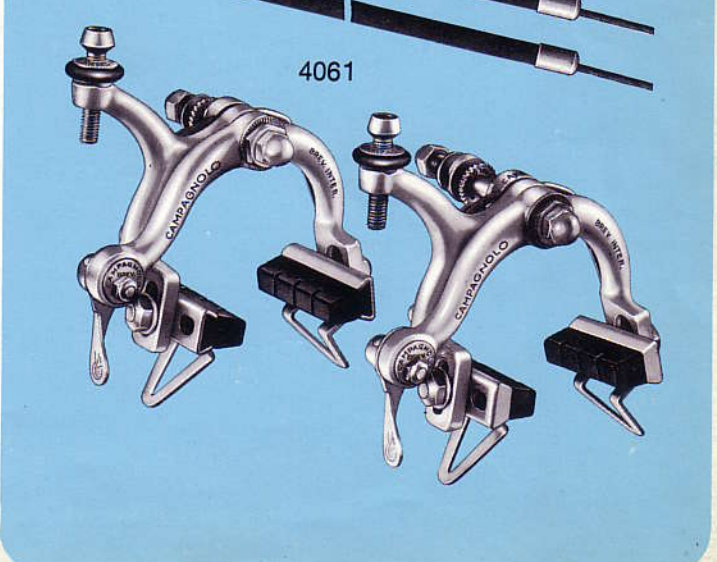
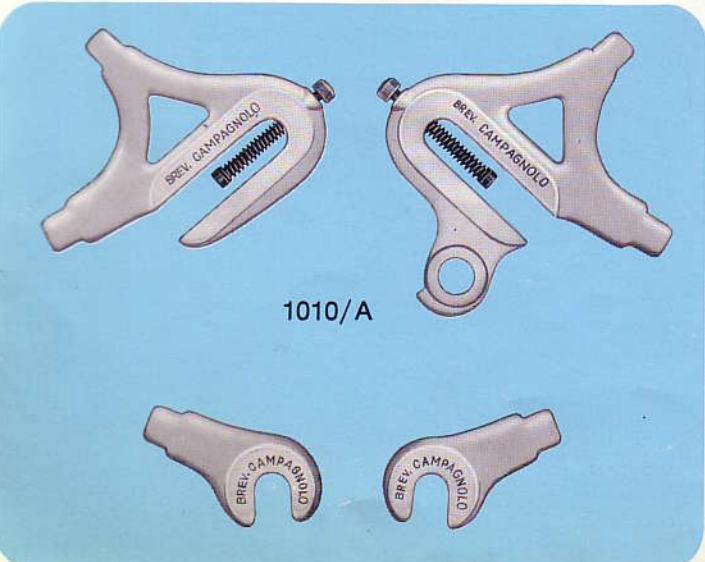
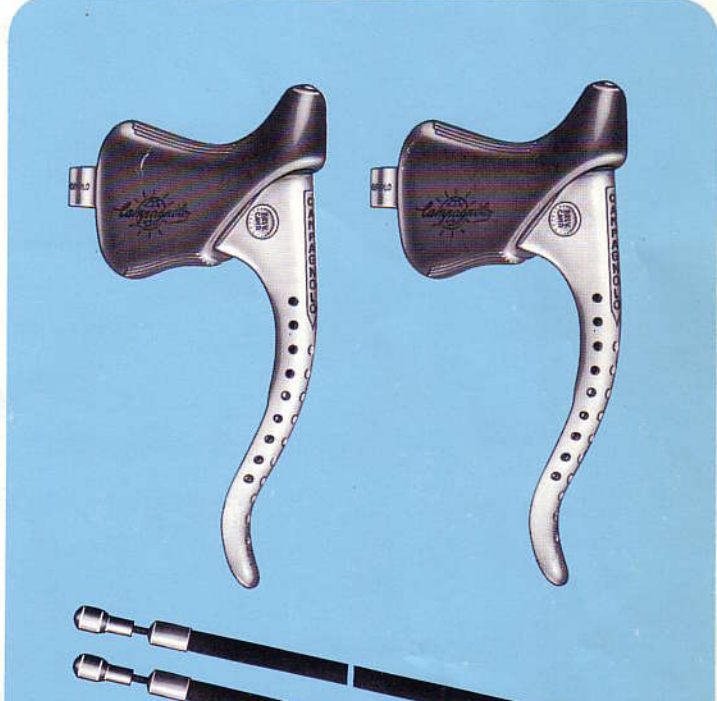

PARTICULAR COMPONENTS OF CAMPAGNOLO SUPER RECORD ROAD GROUP 4000/F

- 4001 Super Record gear
- 82/A Body ferrule
- 84 Gear return spring screw
- 88 Clamp washer
- 93/A Sprocket bolt
- 98/A Gear return spring
- 99 Gear adjusting screw
- 124 Fixing screw
- 807/A Inner arm
- 808/A Spindle
- 810/1A Lower body bush
- 812/1A Grub screw
- 813/A Tension spring

- 814/A Outer cage plate
- 815/A Inner cage plate
- 930/A Roller
- 931/A Roller bush
- 937 Roller dust cover
- 4002 Upper body
- 4003 Spring cage
- 4004 Upper pivot Titanium bolt
- 4005 Spring cage Titanium bolt
- 4006 Front arm
- 4007 Adjusting bolt upper spring
- 4008 Adjusting bolt lower spring
- 4009 Spring cage cover

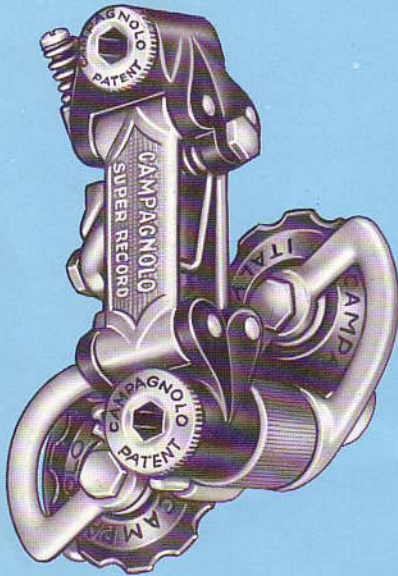

4001

